

# Installation Instruction

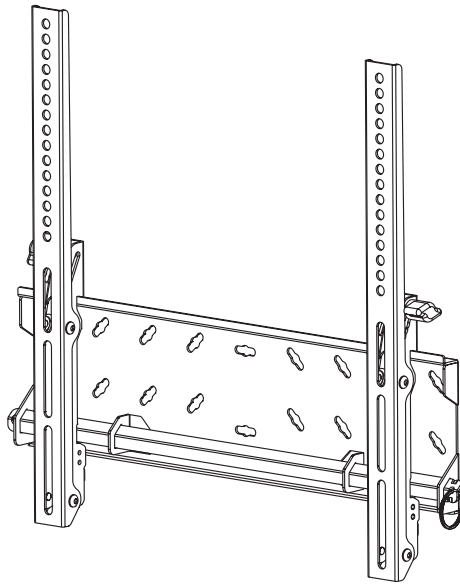

## UNPACKING INSTRUCTIONS

- Carefully open the carton, remove contents and lay out on cardboard or other protective surface to avoid damage.
- Check package contents against the Supplied Parts List in the next page to assure that all components were received undamaged. Do not use damaged or defective parts.
- Carefully read all instructions before attempting installation.

## IMPORTANT SAFETY INFORMATION

Install and operate this device with care. Please read this instruction before beginning the installation, and carefully follow all instructions contained herein. Use proper safety equipment during installation.

Please call a qualified installation contractor for help if you:

- If you don't understand these directions or have any doubts about the safety of the installation.
- If you are uncertain about the nature of your wall, consult a qualified installation contractor.

Do not use this product for any purpose or in any configuration not explicitly specified in this instruction. We hereby disclaim any and all liability for injury or damage arising from incorrect assembly, incorrect mounting, or incorrect use of this product.



**WARNING**

## CAUTION!

**This TV mount must be securely attached to the vertical wall. If the mount is not properly installed it may fall, resulting in possible injury and/or damage.**

Tools Required

- |   |  |   |
|---|--|---|
| <ul style="list-style-type: none"> <li>■ 3.8mm Drill Bit</li> <li>■ Phillips Screwdriver</li> </ul> | <ul style="list-style-type: none"> <li>■ 8mm Masonry Bit</li> <li>■ Stud Finder</li> </ul> | <ul style="list-style-type: none"> <li>■ Wrench or Socket Set</li> <li>■ Carpenter's Level</li> </ul> |
|---|--|---|

**Note:** The mounting components and hardware supplied in this package are not designed for installations to walls with steel studs or to cinder block walls. If the hardware you need for your installation is not included, please consult your local hardware store for proper mounting hardware for the application.

# Supplied Parts List

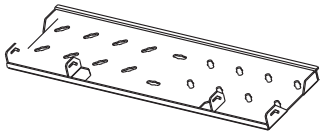

(1)Wall Plate

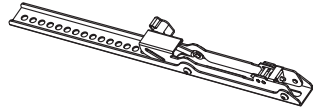

(1)Left Monitor Bracket

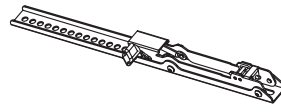

(1)Right Monitor Bracket

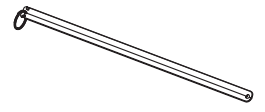

(1)Locking Bar

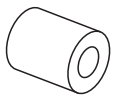

(4)M4 Spacer-A



(8)5mm M6/M8  
Spacer-B

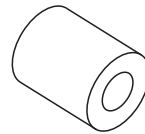

(4)20mm M6/M8  
Spacer-C

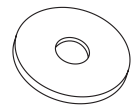

(4)M4 Washer-D

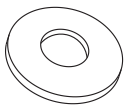

(4)M6 Washer-E

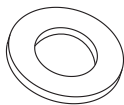

(4)M8 Washer-F



(4)M4x12 Bolt-G



(4)M4x30 Bolt-H



(4)M6x20 Bolt-J



(4)M6x35 Bolt-K

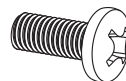

(4)M8x20 Bolt-L

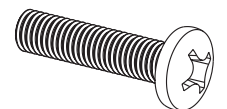

(4)M8x35 Bolt-M

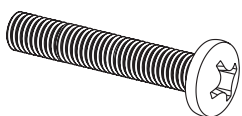

(4)M8x45 Bolt-N

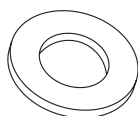

(5)Lag Bolt Washer-X

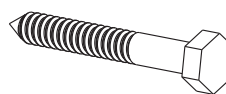

(5)M6x45mm Lag Bolt-Y

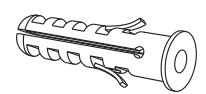

(5)M8x50mm  
Concrete Anchor-Z

# Step 1

## Mounting the Wall Plate to the Wall

### Brick or Concrete Wall

1.1

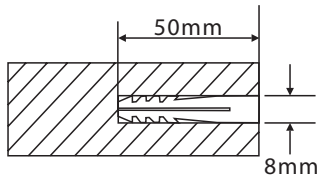
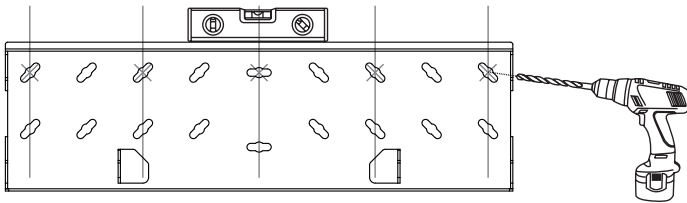

1.2a

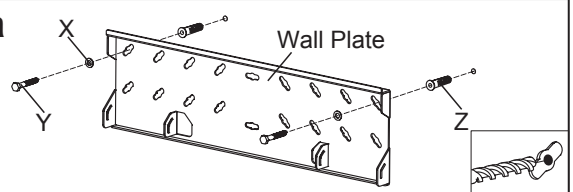

1.2b

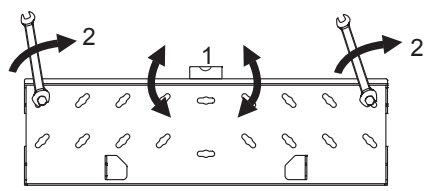

1.2c

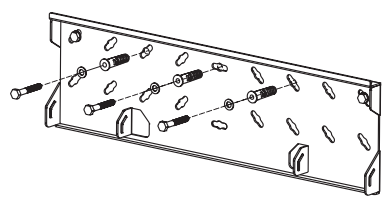

### Wood Studs Wall

1.1

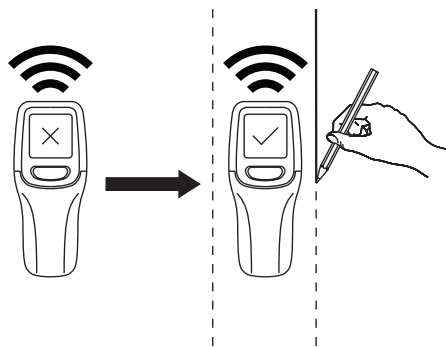

1.2

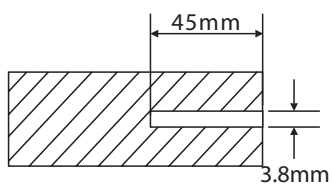
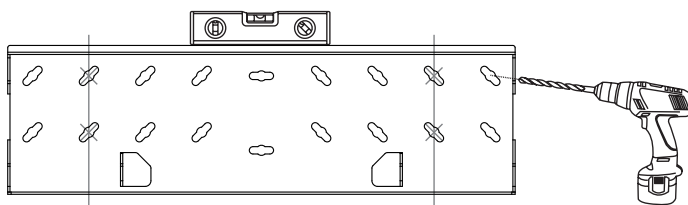

1.3

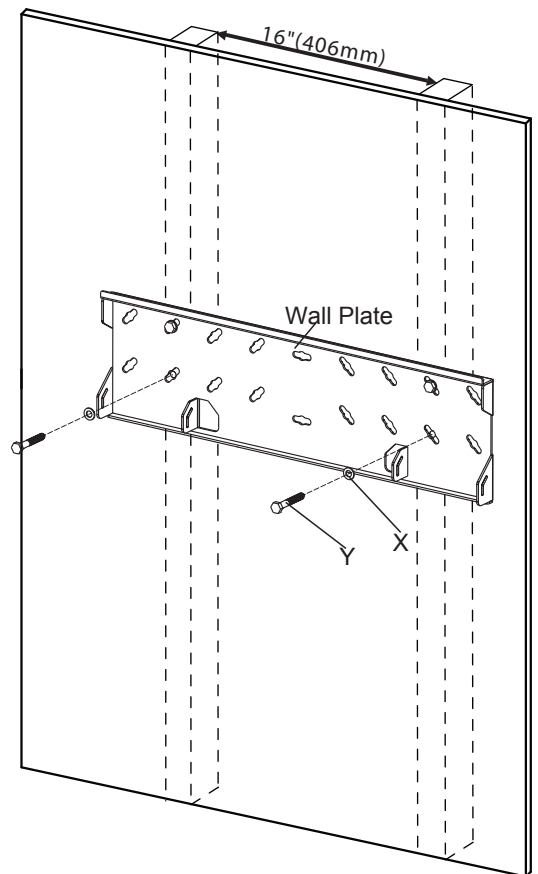

## Step 2

### Mounting the Monitor Brackets to a TV

#### 2.1 G/H/J/K/L/M/N

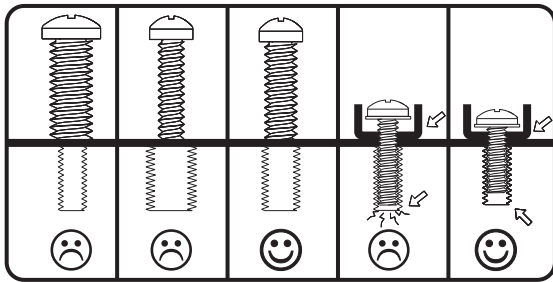

#### 2.2 A/B/C (Optional)

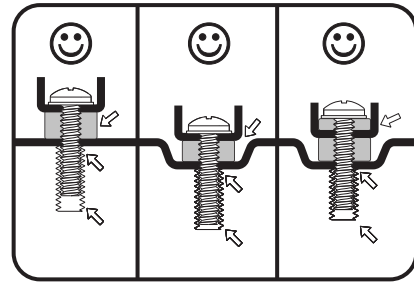

#### 2.3

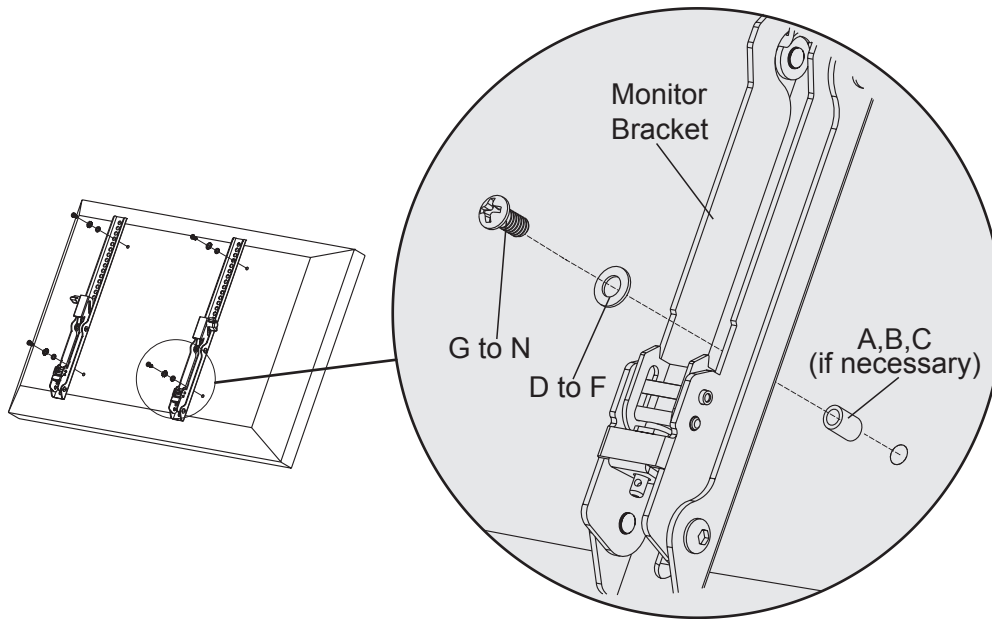

## Step 3

### Inserting the Locking Bar and Attaching Monitor to Wall Plate

**Warning: Some TVs may require two people to lift! We are not responsible for personal injury or product damage.**

Insert the Locking Bar to the Wall Plate as shown in the 3.1, add the padlock (not supplied) at the end of locking bar if necessary. Once the locking bar was installed, hook the Monitor Brackets over the top of the Wall Plate, then let the bottom of the Monitor Brackets rotate to the bottom of the Wall Plate as shown in the 3.2. Push the bottom of TV to lock the Monitor Brackets on the Wall Plate as shown in the 3.3. Loose the knobs on both Monitor Brackets to adjust the tilt angle according to your requirement. Pull out the Locking Bar first if you want to remove the TV from the Wall Plate.

#### 3.1

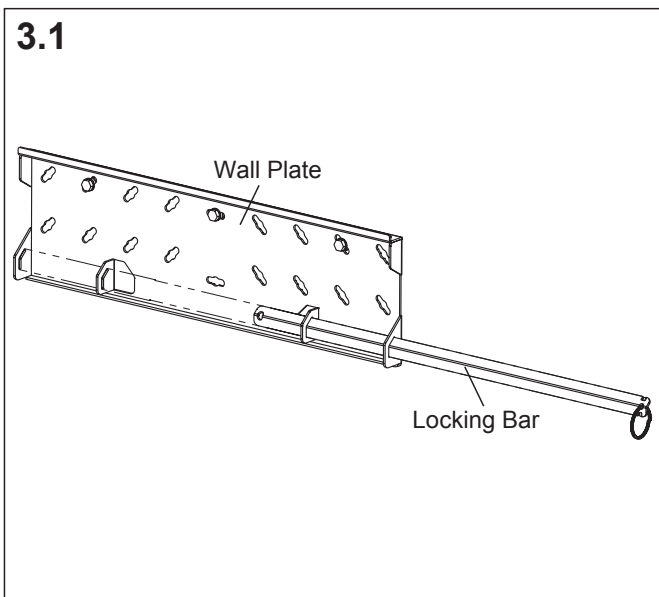

#### 3.2

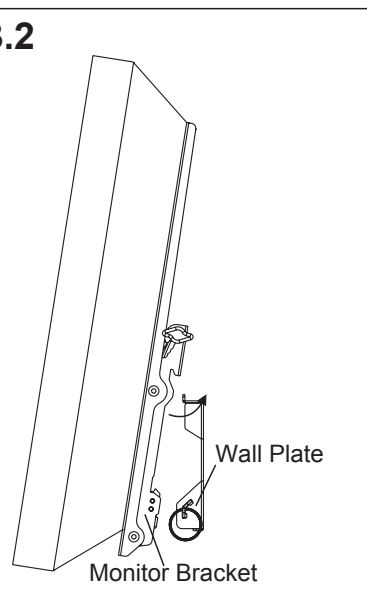

#### 3.3

