

Installation Instruction

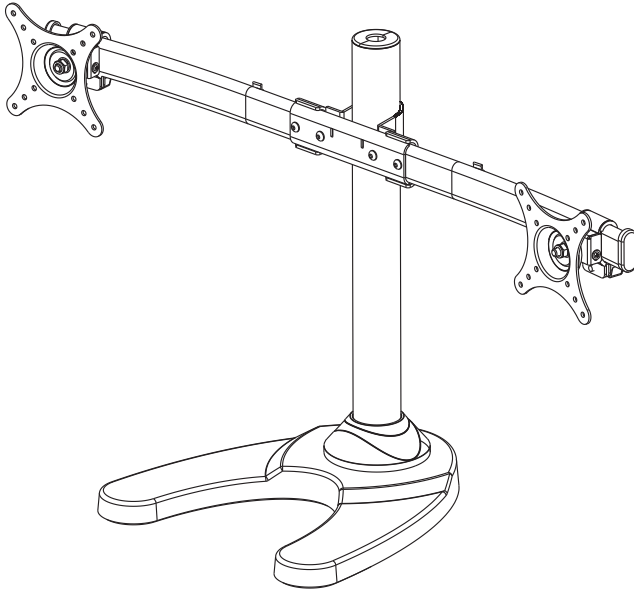

UNPACKING INSTRUCTIONS

- ! Carefully open the carton, remove contents and lay out on cardboard or other protective surface to avoid damage.
- ! Check package contents against the Supplied Parts List in the next page to assure that all components were received undamaged. Do not use damaged or defective parts.
- ! Carefully read all instructions before attempting installation.

IMPORTANT SAFETY INFORMATION

- ! Install and operate this device with care. Please read this instruction before installation, and carefully follow all instructions contained herein. Use proper safety equipment during installation.
- ! Please call a qualified installation contractor for help if you don't understand these directions or have any doubts about the safety of the installation.

Do not use this product for any purpose or in any configuration not explicitly specified in this instruction. We hereby disclaims any and all liability for injury or damage arising from incorrect assembly, incorrect mounting, or incorrect use of this product.

Supplied Parts List

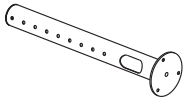

(1) 48mm Pole-a



(1) Weighted Base-b

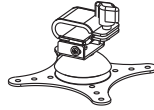

(2) Vesa Plate with Slip Set-c

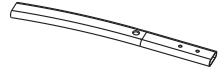

(2) Curved Arm-d

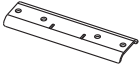

(1) Arm Connect Part-e

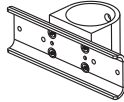

(1) Arm Clamp-f



(4) M6x25 Bolt-g



(4) M6 Washer-h

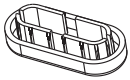

(2) Arm Plastic Cover-i

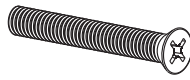

(3) M6x29 Bolt-j



(1) Decorative Cover-k



(1) Grommet Plate-l



(1) M10 Grommet Bolt-m

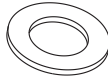

(1) M10 Washer-n1



(1) Spring Washer-n2

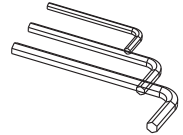

(1) Allen Key-o



(16) M4 Washer-p

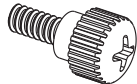

(8) M4x12 Thumb Bolt-q



(8) M4x30 Bolt-r



(8) M4 Space-s

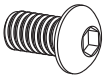

(2) M8x10 Bolt-t

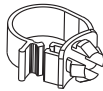

(2) Wire Clip-u



(1) Wrench-v



WARNING

CAUTION!

This monitor desktop mount must be securely installed to the horizontal desk. If the mount is not properly installed it may fall, resulting in possible injury and/or damage.

Step 1

Mounting the base according to your requirement

The stand can be used with the weighted metal base or there is a desk attachment provided (as drawings on the bottom) allowing you to mount the stand on a desk. This is very simple to install and just requires a hole drilling (10mm diameter) in your desk and clamping with the bolt and large washer.

Option 1

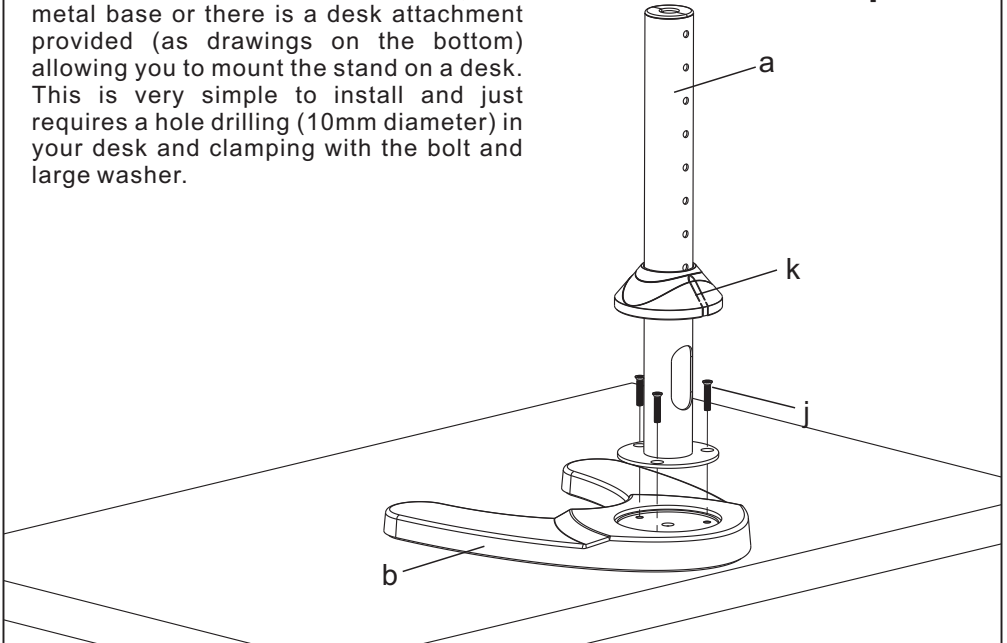

Option 2

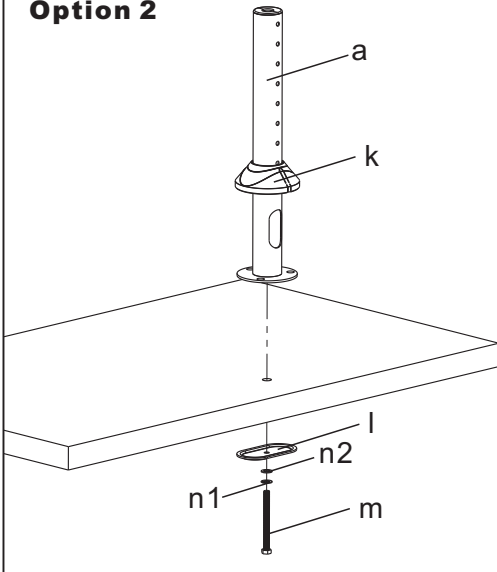

Option 3

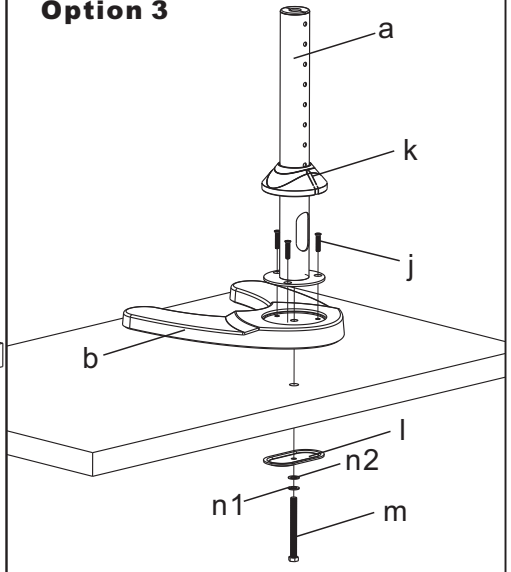

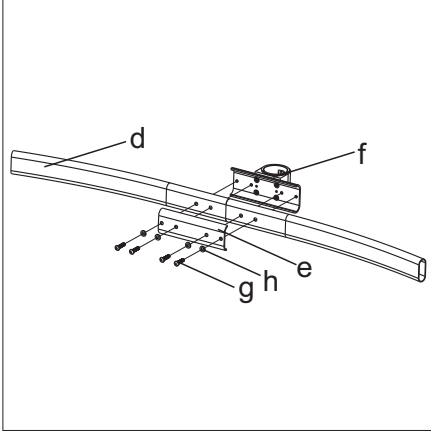
Step 2**Assemble the Arm Sets and Install it on the Pole**

Assemble the curved arm sets as the diagram above, fasten the M6x25 Bolt-g by provided Allen Key-o.

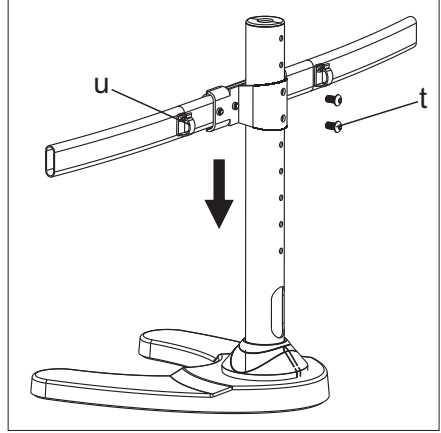

Insert the curved arm sets to pole, fasten the M8x10 Bolt-t by provided Allen Key-o. Install the Wire Clip-u.

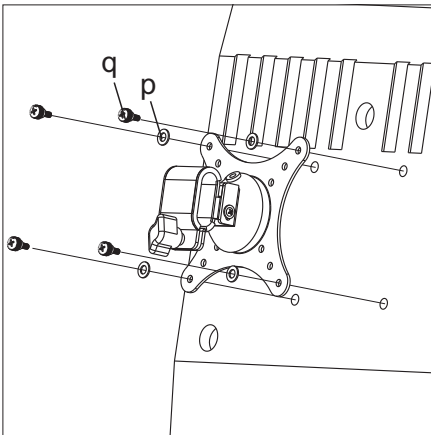
Step 3**Mount the Monitor to VESA Plate**

For Flat Back Monitor

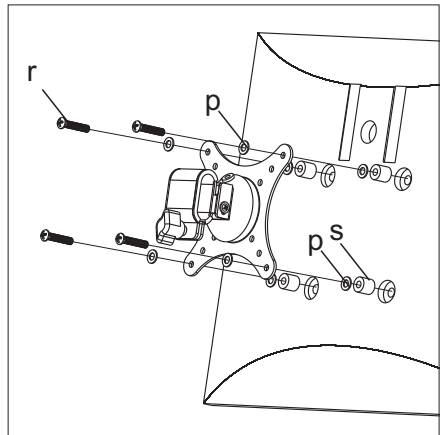

For Curved Back Monitor

Step 4

Attach the Monitors to Arm Sets and Adjust the Tilting Angle

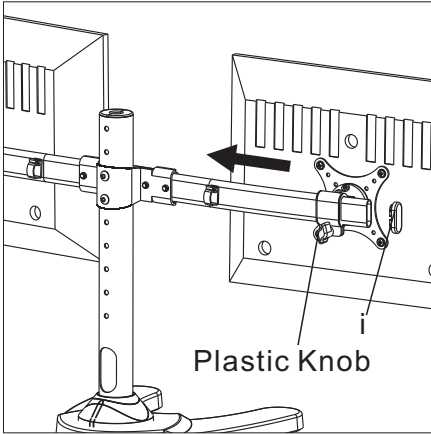

Attaching the monitors to the curved arm sets, fixing the position by the plastic knob. Install the Arm Plastic Cover-i as the above diagram.

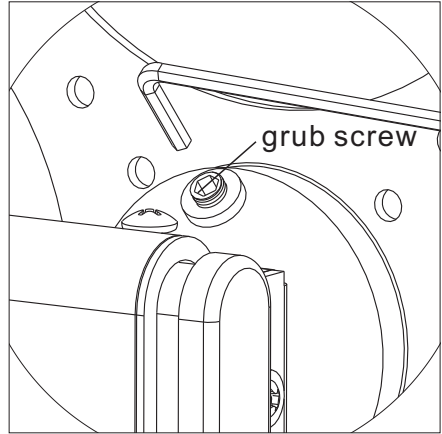

Fasten the grub screw to fix the tilting angle by provided Allen Key-o.

Step 5

Adjust the Monitors Level and Manage the Wires

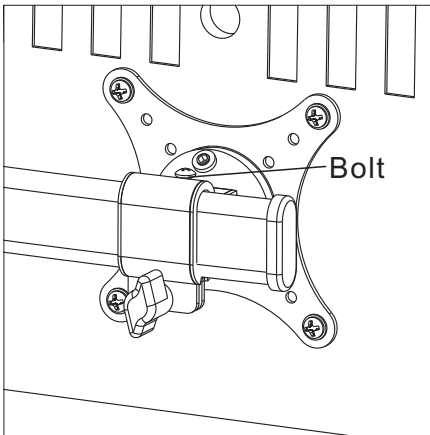

By fasten or loosen the bolt on the above diagram to adjust the level of each monitor.

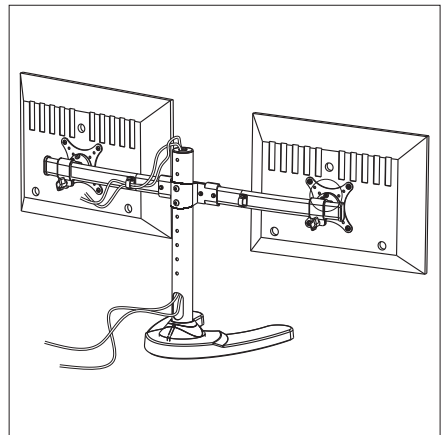

Management the wires as the above diagram.

Thank you for choosing our products!